

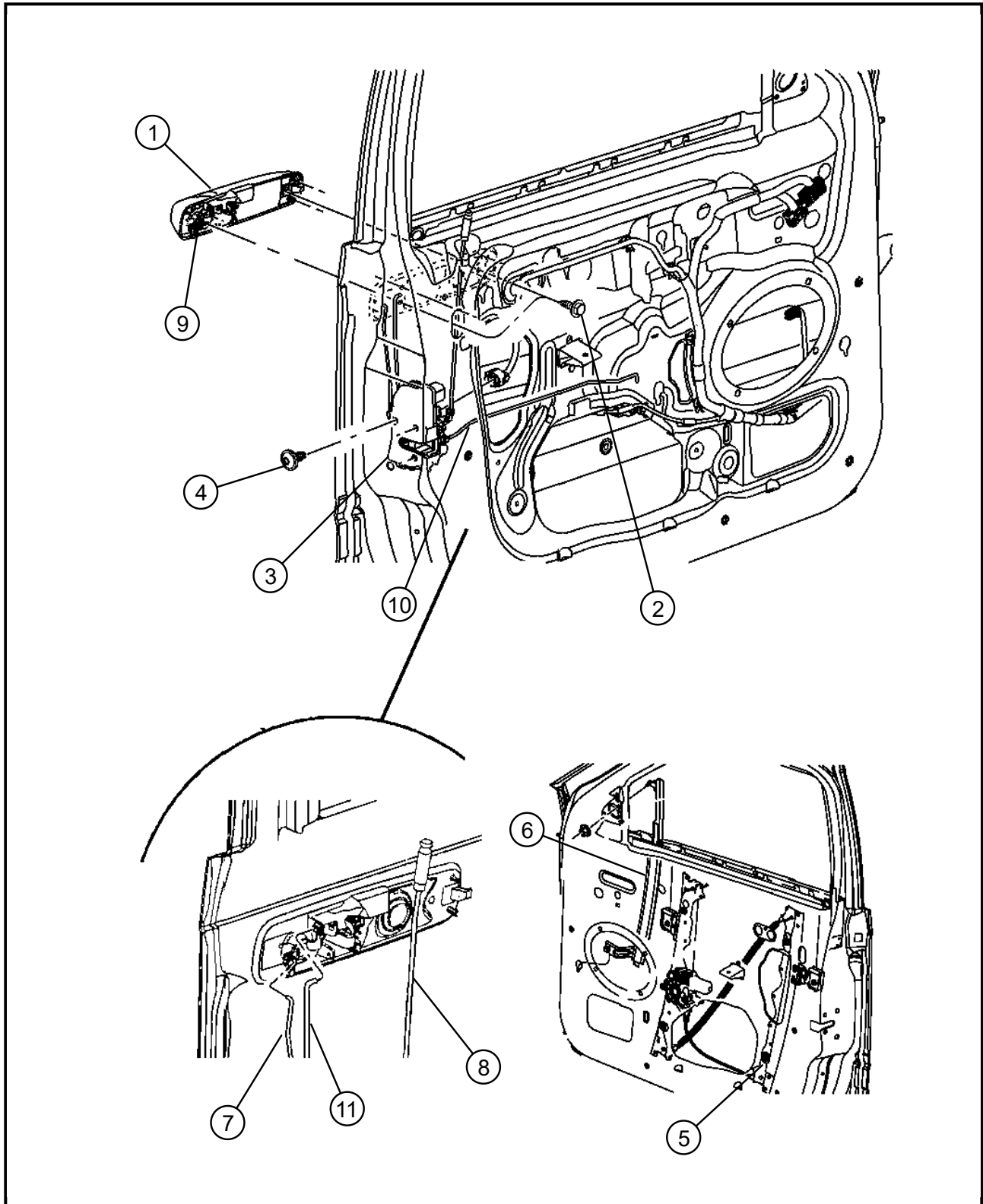





030 - Doors, Door Mirrors and Related Parts/100 - Front Door







DESCRIPTION













Item	Description	Part Number	Qty	Supersedence	Tech Tip	Engine	Trans	Line	Body
1	HANDLE, Exterior Door								
	Right, [XR], Without Lock Cylinder	5HS56AXRAI	1	Yes					
	HANDLE	5HS56AXRAJ	1	Yes					
	Right, [DM], Without Lock Cylinder	5HS56CDMAI	1	Yes					
	HANDLE	5HS56CDMAJ	1	Yes					
	Right, [BM], Without Lock Cylinder	5HS56DBMAI	1	Yes					
	HANDLE	5HS56DBMAJ	1	Yes					
	Right, [X8], Without Lock Cylinder	5HS56DX8AI	1	Yes					
	HANDLE	5HS56DX8AJ	1	Yes					
	Right, [BL], Without Lock Cylinder	5HS56EBLAI	1	Yes					
	HANDLE	5HS56EBLAJ	1	Yes					
	Right, [DA], Without Lock Cylinder	5HS56EDAAI	1	Yes					
	HANDLE	5HS56EDAAJ	1	Yes					
	Right, [GJ], Without Lock Cylinder	5HS56EGJAI	1	Yes					
	HANDLE	5HS56EGJAJ	1	Yes					
	Right, [FG], Without Lock Cylinder	5HS56FFGAI	1	Yes					
	HANDLE	5HS56FFGAJ	1	Yes					
	Right, [W1], Without Lock Cylinder	5HS56SW1AI	1	Yes					
	HANDLE	5HS56SW1AJ	1	Yes					

Item	Description	Part Number	Qty	Supersedence	Tech Tip	Engine	Trans	Line	Body
	Right, [S2], Without Lock Cylinder	5HS56WS2AI	1	Yes					
	HANDLE	5HS56WS2AJ	1	Yes					
	Right, [XR], Without Lock Cylinder	5HS56AXRAI	1	Yes					
	HANDLE	5HS56AXRAJ	1	Yes					
	Right, [DM], Without Lock Cylinder	5HS56CDMAI	1	Yes					
	HANDLE	5HS56CDMAJ	1	Yes					
	Right, [BM], Without Lock Cylinder	5HS56DBMAI	1	Yes					
	HANDLE	5HS56DBMAJ	1	Yes					
	Right, [X8], Without Lock Cylinder	5HS56DX8AI	1	Yes					
	HANDLE	5HS56DX8AJ	1	Yes					
	Right, [BL], Without Lock Cylinder	5HS56EBLAI	1	Yes					
	HANDLE	5HS56EBLAJ	1	Yes					
	Right, [DA], Without Lock Cylinder	5HS56EDAAI	1	Yes					
	HANDLE	5HS56EDAAJ	1	Yes					
	Right, [GJ], Without Lock Cylinder	5HS56EGJAI	1	Yes					
	HANDLE	5HS56EGJAJ	1	Yes					
	Right, [FG], Without Lock Cylinder	5HS56FFGAI	1	Yes					
	HANDLE	5HS56FFGAJ	1	Yes					
	Right, [W1], Without Lock Cylinder	5HS56SW1AI	1	Yes					

Item	Description	Part Number	Qty	Supersedence	Tech Tip	Engine	Trans	Line	Body
	HANDLE	5HS56SW1AJ	1	Yes					
	Right, [S2], Without Lock Cylinder	5HS56WS2AI	1	Yes					
	HANDLE	5HS56WS2AJ	1	Yes					
	Right, [XR], Without Lock Cylinder	5HS56AXRAI	1	Yes					
	HANDLE	5HS56AXRAJ	1	Yes					
	Right, [DM], Without Lock Cylinder	5HS56CDMAI	1	Yes					
	HANDLE	5HS56CDMAJ	1	Yes					
	Right, [BM], Without Lock Cylinder	5HS56DBMAI	1	Yes					
	HANDLE	5HS56DBMAJ	1	Yes					
	Right, [X8], Without Lock Cylinder	5HS56DX8AI	1	Yes					
	HANDLE	5HS56DX8AJ	1	Yes					
	Right, [BL], Without Lock Cylinder	5HS56EBLAI	1	Yes					
	HANDLE	5HS56EBLAJ	1	Yes					
	Right, [DA], Without Lock Cylinder	5HS56EDAAI	1	Yes					
	HANDLE	5HS56EDAAJ	1	Yes					
	Right, [GJ], Without Lock Cylinder	5HS56EGJAI	1	Yes					
	HANDLE	5HS56EGJAJ	1	Yes					
	Right, [FG], Without Lock Cylinder	5HS56FFGAI	1	Yes					
	HANDLE	5HS56FFGAJ	1	Yes					

Item	Description	Part Number	Qty	Supersedence	Tech Tip	Engine	Trans	Line	Body
	Right, [W1], Without Lock Cylinder	5HS56SW1AI	1	Yes					
	HANDLE	5HS56SW1AJ	1	Yes					
	Right, [S2], Without Lock Cylinder	5HS56WS2AI	1	Yes					
	HANDLE	5HS56WS2AJ	1	Yes					
	Left, [XR], Without Lock Cylinder	5HS57AXRAI	1	Yes					
	HANDLE	5HS57AXRAJ	1	Yes					
	Left, [DM], Without Lock Cylinder	5HS57CDMAI	1	Yes					
	HANDLE	5HS57CDMAJ	1	Yes					
	Left, [BM], Without Lock Cylinder	5HS57DBMAI	1	Yes					
	HANDLE	5HS57DBMAJ	1	Yes					
	Left, [X8], Without Lock Cylinder	5HS57DX8AI	1	Yes					
	HANDLE	5HS57DX8AJ	1	Yes					
	Left, [BL], Without Lock Cylinder	5HS57EBLAI	1	Yes					
	HANDLE	5HS57EBLAJ	1	Yes					
	Left, [DA], Without Lock Cylinder	5HS57EDAAI	1	No					
	Left, [GJ], Without Lock Cylinder	5HS57EGJAI	1	Yes					
	HANDLE	5HS57EGJAJ	1	Yes					
	Left, [FG], Without Lock Cylinder	5HS57FFGAI	1	Yes					
	HANDLE	5HS57FFGAJ	1	Yes					

Item	Description	Part Number	Qty	Supersedece	Tech Tip	Engine	Trans	Line	Body
	Left, [W1], Without Lock Cylinder	5HS57SW1AI	1	Yes					
	HANDLE	5HS57SW1AJ	1	Yes					
	Left, [S2], Without Lock Cylinder	5HS57WS2AI	1	Yes					
	HANDLE	5HS57WS2AJ	1	Yes					
	Left, [XR], With Lock Cylinder	5HW79AXRAI	1	Yes					
	HANDLE	5HW79AXRAJ	1	Yes					
	Left, [DM], With Lock Cylinder	5HW79CDMAI	1	Yes					
	HANDLE	5HW79CDMAJ	1	Yes					
	Left, [BM], With Lock Cylinder	5HW79DBMAI	1	Yes					
	HANDLE	5HW79DBMAJ	1	Yes					
	Left, [X8], With Lock Cylinder	5HW79DX8AI	1	Yes					
	HANDLE	5HW79DX8AJ	1	Yes					
	Left, [BL], With Lock Cylinder	5HW79EBLAI	1	Yes					
	HANDLE	5HW79EBLAJ	1	Yes					
	Left, [DA], With Lock Cylinder	5HW79EDAAI	1	Yes					
	HANDLE	5HW79EDAAJ	1	Yes					
	Left, [GJ], With Lock Cylinder	5HW79EGJAI	1	Yes					
	HANDLE	5HW79EGJAJ	1	Yes					
	Left, [FG], With Lock Cylinder	5HW79FFGAI	1	Yes					
	HANDLE	5HW79FFGAJ	1	Yes					
	Left, [W1], With Lock Cylinder	5HW79SW1AI	1	Yes					
	HANDLE	5HW79SW1AJ	1	Yes					

Item	Description	Part Number	Qty	Supersedence	Tech Tip	Engine	Trans	Line	Body
	Left, [S2], With Lock Cylinder	5HW79WS2AI	1	Yes					
	HANDLE	5HW79WS2AJ	1	Yes					
2	SCREW, Tapping	06508074AA	6	No					
3	LATCH, Front Door								
	Left, With Keyed Entry	55113367AA	1	Yes					
	LATCH	55113367AB	1	Yes					
	LATCH	55113367AC	1	Yes					
	Right, Without Keyed Entry	55113372AA	1	Yes					
	LATCH	55113372AB	1	Yes					
	LATCH	55113372AC	1	Yes					
4	SCREW	06508620AA	6	No					
5	REGULATOR, Front Door Window								
	Right	04589170AE	1	Yes					
	REGULATOR	04589170AF	1	Yes					
	REGULATOR	04589170AG	1	Yes					
	REGULATOR	04589170AH	1	Yes					
	Left	04589171AE	1	Yes					
	REGULATOR	04589171AF	1	Yes					
	REGULATOR	04589171AG	1	Yes					
	REGULATOR	04589171AH	1	Yes					
6	CHANNEL, Front Door Glass								
	Right	55394358AH	1	Yes					
	CHANNEL	55394358AI	1	Yes					
	Left	55394359AH	1	Yes					

Item	Description	Part Number	Qty	Supersedence	Tech Tip	Engine	Trans	Line	Body
	CHANNEL	55394359AI	1	Yes					
7	LINK, Key Cylinder To Latch	05166839AA	1	No					
8	KNOB AND LINK, Door Latch								
	Right	55396906AC	1	No					
	Left	55396907AC	1	No					
9	CLIP, Rod Door Lock	05179176AA	1	No					
10	ROD, Inside Handle to Latch								
	Right	05166835AA	1	No					
	Left	05166837AA	1	No					
11	LINK, Exterior Door Handle								
	Left	05166836AA	1	No					
	Right	05166838AA	1	No					

Note: The item number that is listed in negative(-) indicates there is no illustration available.